



everything
water & energy

*Refresh
your bathroom*



Beautiful tile patterns

Sheer colours & textures

Modern & stylish

Elegance & comfort

The timeless classics

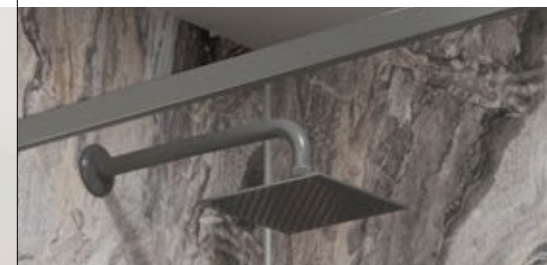
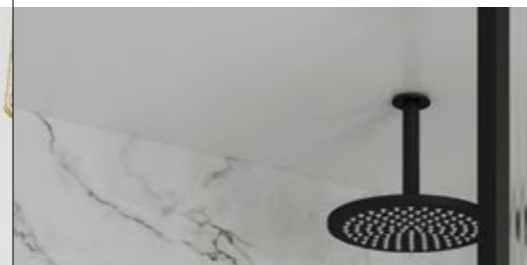

Contents

Tile

Pure

Linda Barker
LINDA BARKER

CONTEMPORARY

CLASSIC

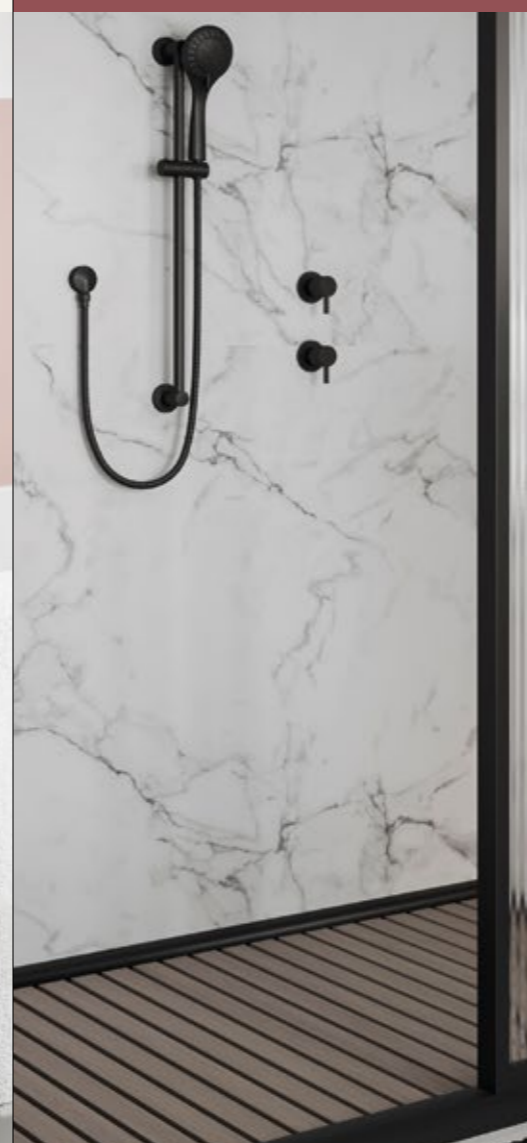

54 Click Flooring

56 Accessories

12

26

34

42

48

Elegant solutions for stylish bathrooms

Create beautiful spaces with Multipanel waterproof bathroom wall panels, the luxurious and modern way to decorate your bathroom. Our beautiful wall panel collections come in a range of sizes and finishes, including marble, stone and wood, offering a range of design possibilities to suit bathrooms of all shapes and sizes.

Hydrolock®, our unique tongue and groove installation system, makes it possible to join panels together without the need for profiles to create a smooth, almost seamless expanse of waterproof walls which will stay pristine for years to come.



Style Guide

Create the perfect pairing with panels from our Tile, Linda Barker, Contemporary and Classic Collections with the subtle tones from the Pure Collection to create a bathroom design that is uniquely yours.

We've carefully selected our favourite combinations to help you create your dream bathroom space. How will you pair yours?

Step 1 Choose your favourite decor

Start by choosing your favourite decor from the Tile, Linda Barker, Contemporary or Classic Collections

Step 2 Find the perfect pairing

Select a colour from the Pure Collection to combine with your feature wall decor

Step 3 Seal the job

Match your profile colour to your shower enclosure and shower fittings (see page 56). Seal your installation using one of our colour match sealants (see page 57)

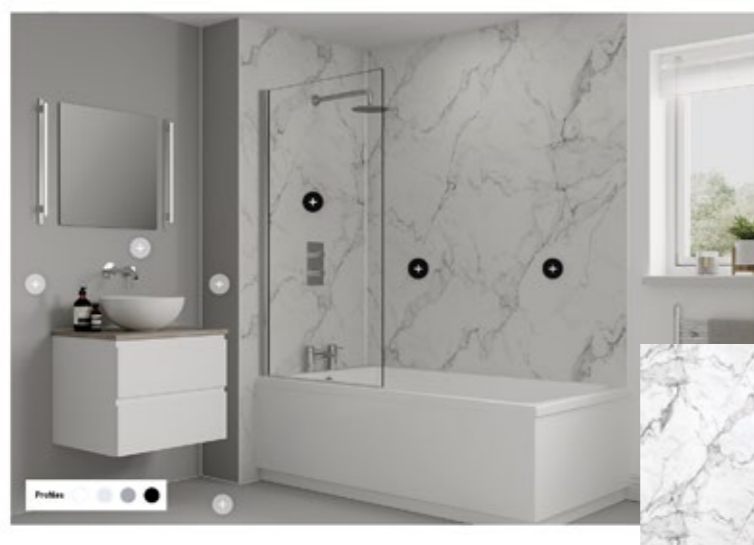

Feature wall decor choice

Pure colour choice

Decor Collection	Senora Stone Contemporary	Misty Blue Tile Large	Black Pietra Linda Barker	Antique Rose Tile Herringbone	Alpine White
Decor Collection	Stone Elements Linda Barker	Levanto Marble Tile Metro	Graphite Elements Linda Barker	Onyx Marble Linda Barker	White Grey
Decor Collection	Sage Green Tile Herringbone	Siena Marble Linda Barker	Salvaged Planked Elm Linda Barker	Corten Elements Linda Barker	Taupe Grey
Decor Collection	Levanto Marble Tile Large	Jupiter Silver Contemporary	Bianca Luna Linda Barker	Alpine White Tile Metro	Dust Grey
Decor Collection	Levanto Marble Tile Herringbone	White Terrazzo Tile Large	Calacatta Marble Linda Barker	Onyx Marble Linda Barker	Monument Grey

Easy to keep clean



Quick and easy to install



Almost seamless joint with Hydrolock®

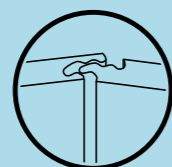

Fully waterproof



30 year warranty



Can be installed over old tiles

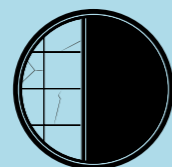

Our company

Since 1881, Grant Westfield has been dedicated to manufacturing exceptional interior building products in Edinburgh. Throughout the course of over 140 years, successive generations have upheld a shared passion for craftsmanship, high quality, and innovation. In 2003, we introduced Multipanel, the United Kingdom's leading bathroom wall panel and in over two decades sales have grown to over 1 million square metres per year.

The launch of the Multipanel range aimed to offer a contemporary alternative to traditional tiles—one that not only boasts an appealing aesthetic but also ensures effortless installation and convenient maintenance. The range has evolved significantly, now encompassing an extensive selection of cutting-edge designs. From trendy plain colours to realistic material reproductions, and most recently, our Tile Collection, which combines the look of tiles with the many advantages of wall panelling.

Hydrolock

We created Hydrolock® to enhance the visual impact of our wall panels. Precisely engineered, the Hydrolock® edge allows panels to be joined together, without the use of mid-joints, to create a smooth, almost seamless expanse of waterproof walls. With an industry leading 6mm tolerance Hydrolock® panels are easy to install and produce a great finish every time.

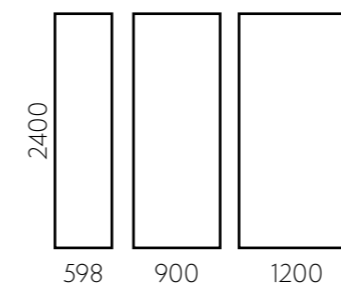

Hydrolock® panels are available in a range of widths for ease of installation;
2400 x 598 mm
2400 x 900 mm
2400 x 1200 mm

*The Hydrolock® joint reduces the finished face by 18mm
i.e. 2400mm x 1200mm becomes 2400 x 1182mm.
Straight edge panels are also available.*

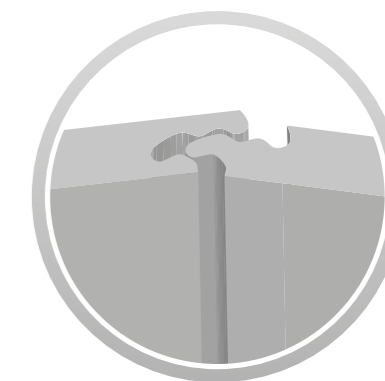

Quality

Our reputation is built on the exceptional quality of our products. We have full confidence in their durability, which is why we offer a comprehensive 30-year warranty (see page 57 for more details). To ensure the highest quality, our raw materials undergo meticulous testing to ensure compatibility with our precise Hydrolock® joint. Our commitment to excellence extends across all aspects of our business, as demonstrated by our ISO 9001:2015 certification for quality management and our ISO 14001 certification for environmental management.

Helping to protect our

forests for the future

Sustainability

Multipanel is FSC®-certified. This ensures the timber we use originates from responsibly managed forests and other controlled sources, and our finished products comply with globally recognised ecological, social and economic standards for complete customer assurance on responsible sourcing.

Our panels are 100% recyclable and we recycle 99% of post-production waste into biomass materials. We have also achieved ISO 14001, demonstrating our commitment to the environment.

Made in Britain

We are proud members of Made in Britain and all Multipanel wall panels are manufactured in our Edinburgh factory. We source over 90% of our raw materials from the UK & Ireland, supporting the local economy and minimising our impact on the environment.



The mark of
responsible forestry

By buying Multipanel® you help to
take care of the world's forests

Look for our
FSC®-certified products



100%

Tile

Looks like tile,
performs like
a panel

Tile Collection

If you love the appearance of traditional tiles but are tired of living with the maintenance of grout, the Multipanel Tile Collection is what you have been waiting for.

The Tile Collection is the first tile-effect wall panel to be Made in Britain and FSC®-certified. Using the very latest in manufacturing technology, we etch a 2.5mm pale grey grout line into our Tile Collection décors, creating a beautiful tile effect with laser precision. Unlike traditional tiles, these tile effect panels are simple to clean and easy to maintain.



Levanto Marble
Large - The Tile Collection

Large Tile



Large Tile Collection

The Large Tile Collection has been specifically designed to create the illusion of depth and open space and looks stunning in big and small bathrooms alike. Explore our range of matt, cool-toned neutrals or our spectacular marbles and mineral effects.

Thanks to state-of-the-art manufacturing technology the panels in the Large Tile Collection look and feel like real ceramic tiles. The grout line is purely decorative and requires no maintenance but still evokes that classic, timeless look.





Misty Blue
Large - The Tile Collection

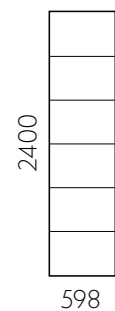

Panel size information

Panels in the Tile Collection are 598mm wide and all feature our Hydrolock® edge. Please note that the Hydrolock® edge reduces the finished face of the panel by 18mm, i.e. 2400mm x 598mm becomes 2400mm x 580mm.

Tile size is 580mm x 400mm with a 2.5mm grout line.

All panels are 11mm thick.

Large Tile Collection

Marble

These marble décors each have a beautiful variation in shades from the grey nuances of Valmasino, the crystalline marbling of Levanto through to the lively Terrazzo, each with a beautiful satin finish.

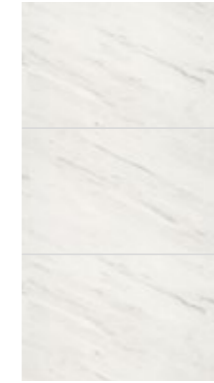

Levanto Marble*
MT812

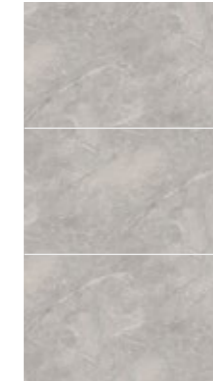

Valmasino Marble*
MT074

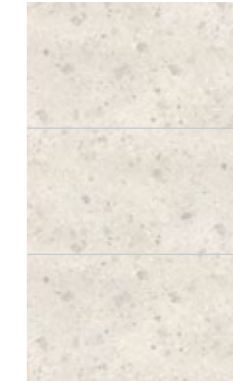

White Terrazzo*
MT020

Mineral

These décors combine the characteristics of different materials; think concrete, granite and quartz, finished with a beautiful velvety feel.

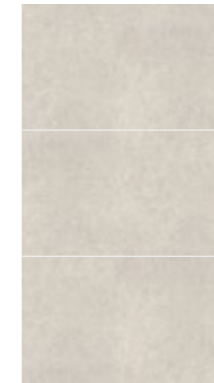

White Mineral*
MT486



Grey Mineral*
MT487

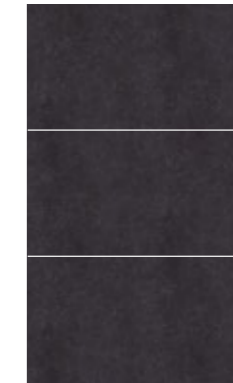

Black Mineral*
MT490

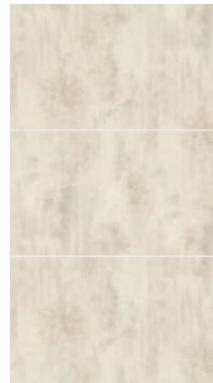

White Gypsum*
MT637

Colour

These solid, bold colours offer a strong neutral palette and work well on their own or when combined. The smooth matt finish is very on-trend.

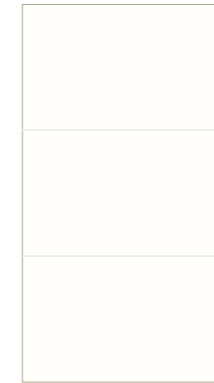

Alpine White*
MT1100



Dust Grey*
MT732

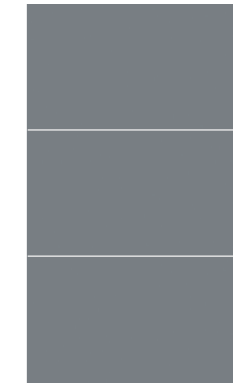

Monument Grey*
MT780

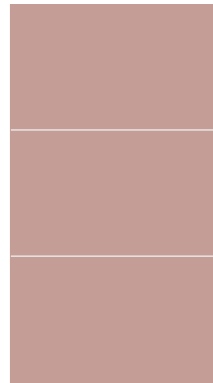

Antique Rose*
MT325

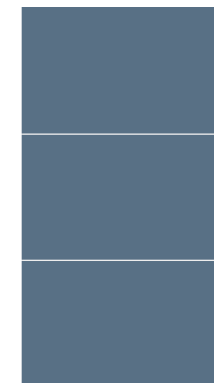

Misty Blue*
MT502

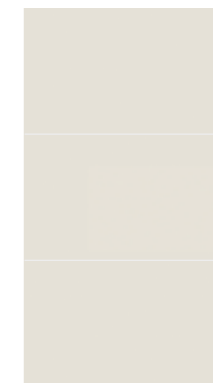

White Grey*
MT775

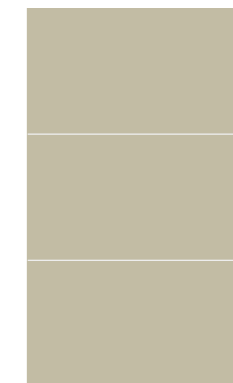

Sage Green*
MT638

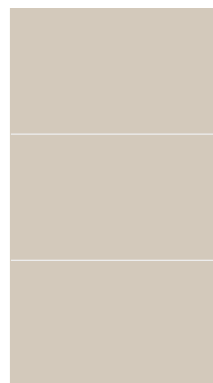

Taupe Grey*
MT750

We recommend the use of our light grey sealant, it perfectly matches the grout colour in the Tile Collection.

*These panels are also available without a tile effect in our Pure Collection on Page 26.

Herringbone Tile

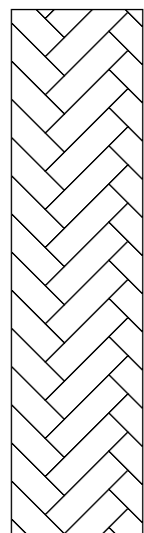

Herringbone Collection

Add a touch of sophistication to your bathroom with Multipanel herringbone wall panels. This elegant design looks stunning when installed at full or half height.

The tile effect is achieved with the latest manufacturing technology, which precisely etches decorative grout lines into the panels. The Herringbone Collection has all the benefits of our wall panels, but with no grout to maintain, your bathroom will look brand new for years to come.



Dust Grey
Herringbone - The Tile Collection

Levanto Marble
The Pure Collection



Herringbone Tile Collection

Marble

Levanto marble creates a timeless effect, displaying a range of shades from grey to a subtle blush pink. The sleek matt finish of this tile effect panel adds an elegant touch to any bathroom.



Levanto Marble*
MT812H

Colour

These solid, bold colours offer a strong neutral palette and work well on their own or when combined. The smooth matt finish is very on-trend.



Alpine White*
MT1100H

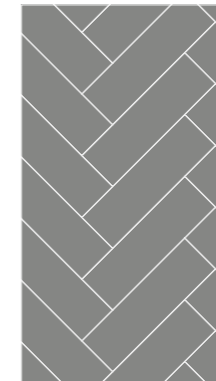

Dust Grey*
MT732H



Monument Grey*
MT780H

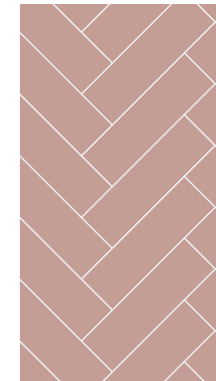

Antique Rose*
MT325H



Misty Blue*
MT502H



White Grey*
MT775H



Sage Green*
MT638H



Taupe Grey*
MT750H

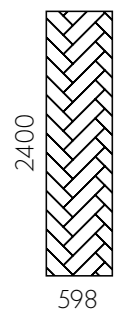

Panel size information

Panels in the Tile Collection are 598mm wide and all feature our Hydrolock® edge. Please note that the Hydrolock® edge reduces the finished face of the panel by 18mm, i.e. 2400mm x 598mm becomes 2400mm x 580mm.

Tile size is 410mm x 123mm with a 2.5mm grout line.

All panels are 11mm thick.

We recommend the use of our light grey sealant, it perfectly matches the grout colour in the Tile Collection.

**These panels are also available without a tile effect in our Pure Collection on Page 26.*

Metro Tile

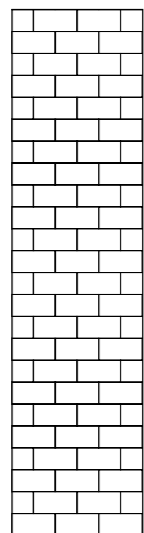

Metro Collection

Our metro tile wall panels bring a sleek, contemporary look finish to your bathroom.

Metro tiles are a timeless tile design which is reminiscent of the London Underground. This pattern looks great as shower cladding or kitchen splashback, but also makes a great feature wall.

The metro tile pattern is achieved with state-of-the-art technology which etches a decorative grout line into the wall panel. No grout means no hassle!



Alpine White
Metro - The Tile Collection

Sage Green
Large - The Tile Collection



Levanto Marble
Metro - The Tile Collection

Metro Tile Collection

Marble

Levanto marble creates a timeless effect, displaying a range of shades from grey to a subtle blush pink. The sleek matt finish of this tile effect panel adds an elegant touch to any bathroom.



Levanto Marble*
MT812M

Colour

These solid, bold colours offer a strong neutral palette and work well on their own or when combined. The smooth matt finish is very on-trend.

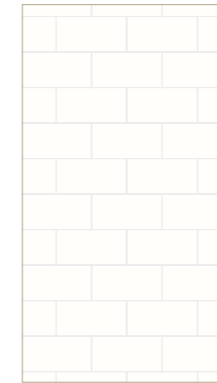

Alpine White*
MT1100M

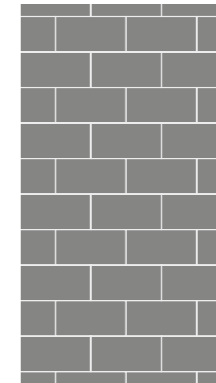

Dust Grey*
MT732M

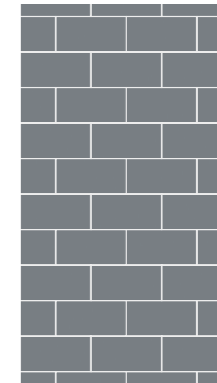

Monument Grey*
MT780M

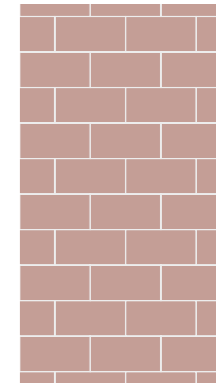

Antique Rose*
MT325M

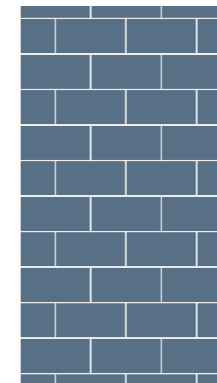

Misty Blue*
MT502M

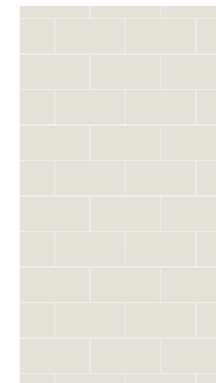

White Grey*
MT775M

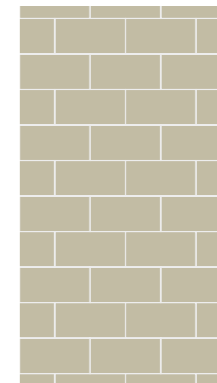

Sage Green*
MT638M

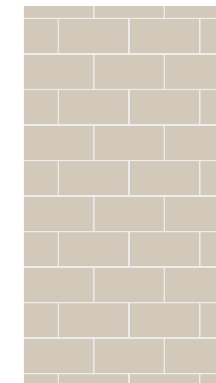

Taupe Grey*
MT750M

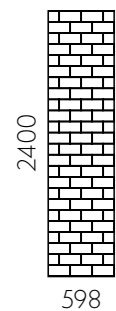

Panel size information

Panels in the Tile Collection are 598mm wide and all feature our Hydrolock® edge. Please note that the Hydrolock® edge reduces the finished face of the panel by 18mm, i.e. 2400mm x 598mm becomes 2400mm x 580mm.

Tile size is 191mm x 97mm with a 2.5mm grout line.

All panels are 11mm thick.

We recommend the use of our light grey sealant, it perfectly matches the grout colour in the Tile Collection.

*These panels are also available without a tile effect in our Pure Collection on Page 26.

Pure

Clean, sheer
finishings of
pure colour &
classic textures

Pure Collection

The Pure Collection includes on-trend designs and textures for a sleek, elegant look.

Renovate your bathroom with our stylish, neutral earth tones or add a touch of colour to your walls with our pinks and blues. If you're looking to recreate that spa-look instead, check out our mineral décors and bestselling marble effects.





Alpine White
The Pure Collection

Antique Rose
The Pure Collection



Valmasino Marble
The Pure Collection

Taupe Grey
Herringbone - The Tile Collection



White Gypsum
The Pure Collection

Taupe Grey
The Pure Collection



Levanto Marble
The Pure Collection

Black Pietra
The Linda Barker Collection

Panel size information

Panels in the Pure Collection are 1200mm wide only.

2400 x 1200 mm (Hydrolock® and straight edge).

All panels are 11mm thick.

Please note the Hydrolock® joint reduces the finished face by 18mm i.e. 2400mm x 1200mm becomes 2400 x 1182mm.

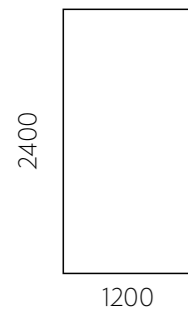

Pure Collection

Marble

These marble décors each have a beautiful variation in shades from the grey nuances of Valmasino, the crystalline marbling of Levanto through to the lively Terrazzo, each with a beautiful satin finish.



Levanto Marble*
MP812

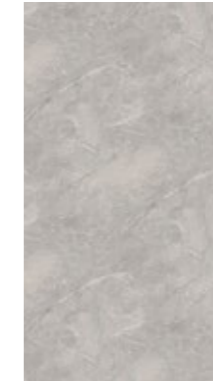

Valmasino Marble*
MP074

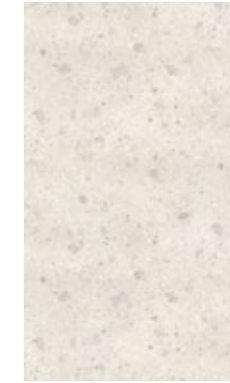

White Terrazzo*
MP020

Mineral

These décors combine the characteristics of different materials; think concrete, granite and quartz, finished with a beautiful velvety feel.

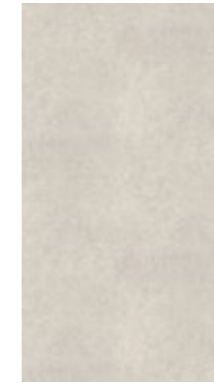

White Mineral*
MP486



Grey Mineral*
MP487



Black Mineral*
MP490



White Gypsum*
MP637

Colour

These solid, bold colours offer a strong neutral palette and work well on their own or when combined. The smooth matt finish is very on-trend.

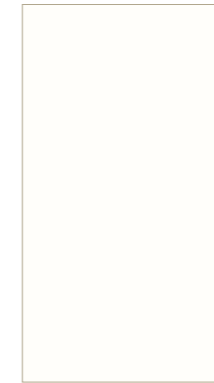

Alpine White*
MP1100



Dust Grey*
MP732



Monument Grey*
MP780

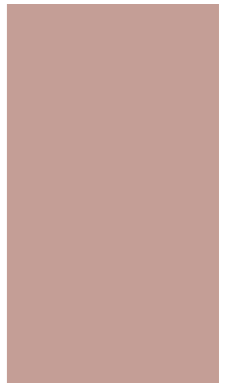

Antique Rose*
MP325



Misty Blue*
MP502

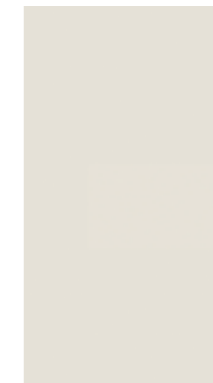

White Grey*
MP775



Sage Green*
MP638

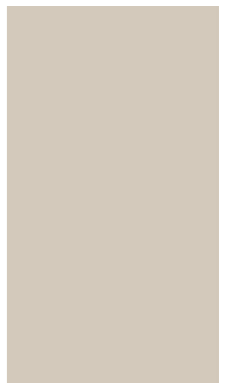

Taupe Grey*
MP750

*These panels are also available with tile effect in our Tile Collection page 12.

"Whether your bathroom is small or large, light or dark, my collection offers you a modern and stylish way of transforming it from a functional space into one that is truly special."



Linda Barker
LINDA BARKER

Add a touch
of luxury

Linda Barker
Collection

Curated by interior designer, Linda Barker, and exclusive to Multipanel, the collection is inspired by the natural world with marble, granite and wood panels that look and feel like the real thing.



Onyx Marble
The Linda Barker Collection



Calacatta Marble
The Linda Barker Collection

White Grey
The Pure Collection



Concrete Elements
The Linda Barker Collection



Siena Marble
The Linda Barker Collection

Taupe Grey
The Pure Collection



Black Pietra
The Linda Barker Collection

Linda Barker Collection

Marble

These panels emulate the look and feel of real slabs of marble, helping you to achieve a truly luxurious, high end look.



Calacatta Marble
3460

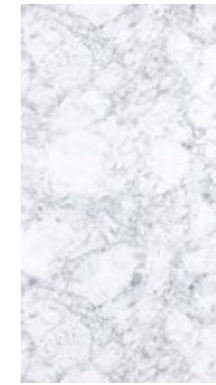

Bianca Luna
3421

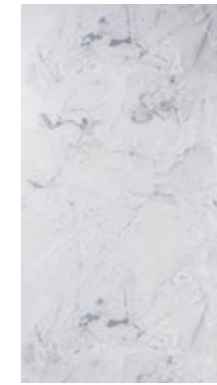

Onyx Marble
5545

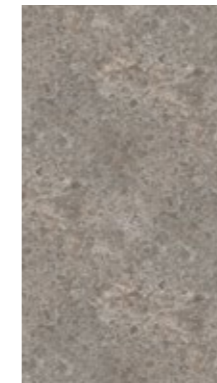

Siena Marble
095



Black Pietra
206

Elements

These textured panels feel and look like real stone, steel and mineral elements - perfect for achieving an ultra-modern industrial look.

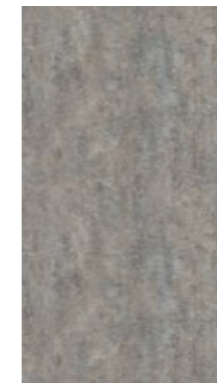

Stone Elements
8831

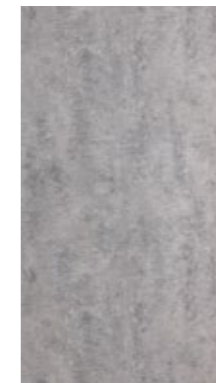

Concrete Elements
8830



Corten Elements
8832



Graphite Elements
8833

Wood

With a softly weathered look, these panels will transform your bathroom into a place of calm and tranquillity, allowing you to bring outdoor elements indoors.



Salvaged Planked Elm
9480



Concrete Formwood
6362

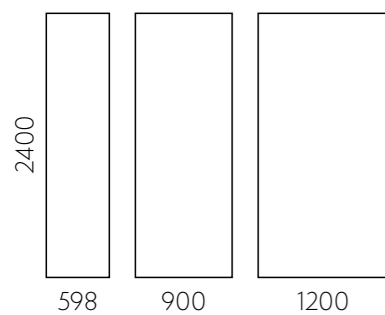

Panel size information

Panels are available in a range of widths for ease of installation;

- 2400 x 598 mm (Hydrolock® and straight edge)
- 2400 x 900 mm (Hydrolock® and straight edge)
- 2400 x 1200 mm (Hydrolock® and straight edge)

All panels are 11mm thick.

The Hydrolock® joint reduces the finished face by 18mm i.e. 2400mm x 1200mm becomes 2400 x 1182mm.

CONTEMPORARY

Elegance
& comfort
inspired by
nature

Contemporary Collection

Transform your bathroom into an oasis of tranquility with the Contemporary Collection. From textured stone to creamy marble with delicate veins, the neutral colours and textures in this collection are designed to evoke a sense of peace.





Arctic Stone
The Contemporary Collection

White Grey
The Pure Collection





Tavolo Taupe
The Contemporary Collection

Taupe Grey
The Pure Collection

Contemporary Collection

These décors provide the appearance of solid real stone without the associated price tag. Not only are our stone effect panels great value, their light weight nature makes them quick and easy to install - unlike real stone panelling.

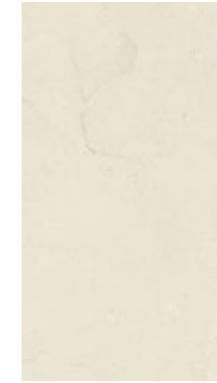

Marfil Cream
9477



Jupiter Silver
3458



Arctic Stone
3331



Senora Stone
041

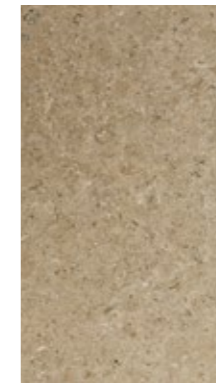

Tavolo Taupe
127

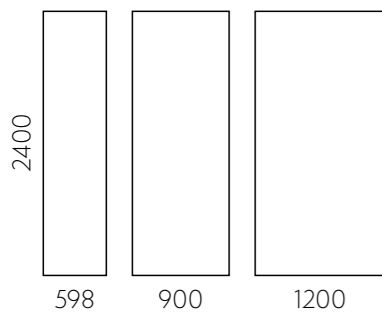

Panel size information

Panels are available in a range of widths for ease of installation;

- 2400 x 598 mm (Hydrolock® and straight edge)
- 2400 x 900 mm (Hydrolock® and straight edge)
- 2400 x 1200 mm (Hydrolock® and straight edge)

All panels are 11mm thick.

The Hydrolock® joint reduces the finished face by 18mm i.e. 2400mm x 1200mm becomes 2400 x 1182mm.

CLASSIC

Earth, stone &
gloss panels
feature in
this timeless
collection

Classic Collection

With a range of gloss or textured finishes including natural stone, precious stone and marble, the Classic Collection contains a range of designs to suit any bathroom.



Cappuccino Stone
The Classic Collection



Riven Slate
The Classic Collection

White Grey
The Pure Collection



Riven Marble
The Classic Collection

Classic Collection

Marble

These on-trend marble-effect panels allow you to achieve a luxurious, polished look. Their distinctive grey veining makes this panel unique yet elegant.

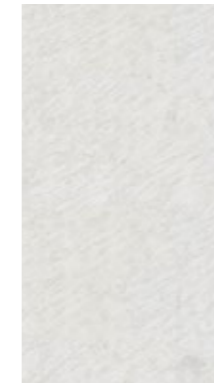

Classic Marble
M141



Antique Marble
701



Grey Marble
M139

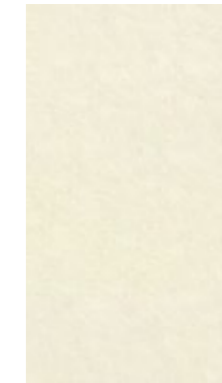

Riven Marble
9241

Sparkles

Add a touch of magic to your bathroom with a touch of shimmer. These panels feature reflective sparkles, catching the light and bouncing a vibrant mix of colours throughout the room.



Stardust
9930



White Snow
9923



Blizzard
G030

Stone

These panels provide a crisp, clean finish to any space. Opt for classic white tones, or bold blacks for a dramatic look.

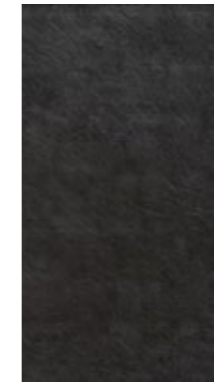

Riven Slate
2859



Cappuccino Stone
7256

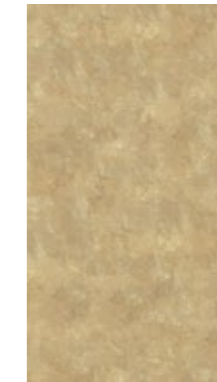

Travertine
M3526

Timeless

Our timeless Frost White and Natural White panels are effortlessly chosen and incredibly easy to live with. These panels have the power to rejuvenate any bathroom, adding a fresh and enduring appeal.

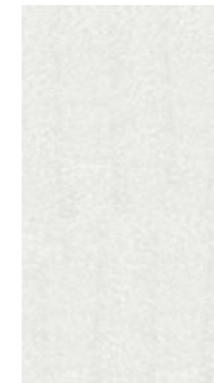

Frost White
M049

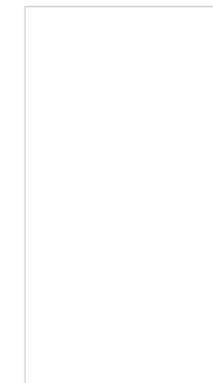

Natural White
G85

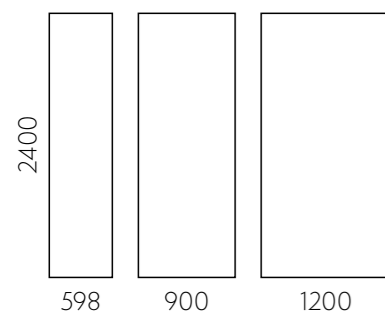

Panel size information

Panels are available in a range of widths for ease of installation;

- 2400 x 598 mm (Hydrolock® and straight edge)
- 2400 x 900 mm (Hydrolock® and straight edge)
- 2400 x 1200 mm (Hydrolock® and straight edge)

All panels are 11mm thick.

The Hydrolock® joint reduces the finished face by 18mm i.e. 2400mm x 1200mm becomes 2400 x 1182mm.



Click Flooring

Luxury tile, stone and wood effect vinyl flooring that offers all the chic styling of ceramics and engineered wood with the added benefit of simplified click installation.

- No need for adhesives or underlay
- 1.84m² coverage per pack (except Driftwood Grey Oak 1.86m²)
- 5.0mm vinyl, 0.5mm wear layer
- R10 slip resistance
- Not suitable for areas exposed to direct sunlight for prolonged periods
- 30 year warranty*



Tile

Adding a luxurious touch to your home, these luxury vinyl tiles are designed to mimic the natural beauty of real stone and marble. Tiles are supplied in packs of 10, each 605 x 304mm.

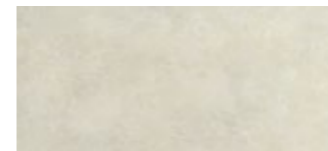

Rimini
MDCRIM



Piemonte
MDCPIE

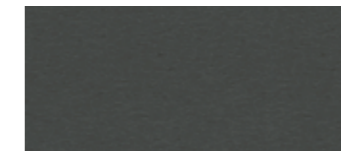

Urban Anthracite Grey
MDCUAG



Sicilia
MDCSIC

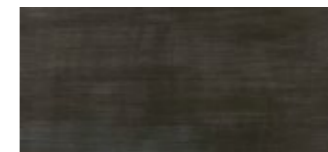

Urban Graphite Grey
MDCUGG

Timber

These beautiful woods will instantly add luxury to your interiors. Choose from the traditional Markham Calhoun Oak or richness of Warm Smoked Oak to the understated Aspen Oak Black for a more minimalist look. Wood planks are supplied in packs of 8, each 1210 x 190mm (except Driftwood Grey Oak, in packs of 7, each 1210 x 220mm)



Markham Calhoun Oak
MDCMAR



Aspen Oak
MDCASP



Driftwood Grey Oak
MDCDGO 1210 x 220mm



Warm Smoked Oak
MDCWSO



Aspen Oak Black
MDCAOB

Premier

Premier comes with added embedded metallic foils to create an eye catching design.



White Diamond
MDCDIA













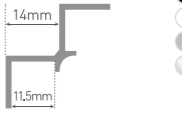

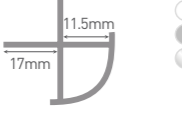
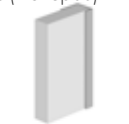
Silver Opal
MDCOPA

*for full warranty terms and conditions please visit our website

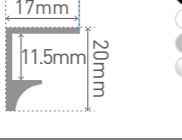
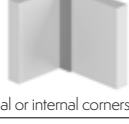
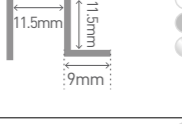
Accessories

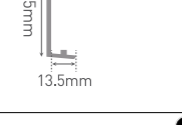
Wall panel profiles

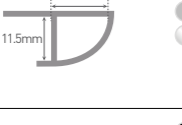
To finish off edges or to join panels in a corner, the appropriate profiles must be used. Use the table below to help you select the right profiles for your design.

Wall Panel Profiles	Aluminium 11.5mm deep
Internal Corner 	Type A 
External Corner 	Type B 
End Cap (L-Shaped) 	Type C 
Mid Joint 	Type D 
Last Corner 	Type Y 
Flush Corner 	Type 100 
For external or internal corners	
Base Profile 	Type X 
Quadrant End Cap 	Type E 
Angle Profile 	Type 102 

Please note: All 3D drawings are a generic representation of the profile type. Dimensions specific to each range are shown on the line drawings.

Available Colours

● Black ○ White ● Satin ● Polished

NEW Invisible Corner

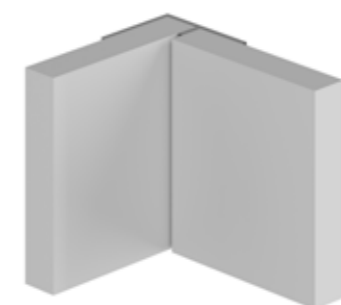

Type 101

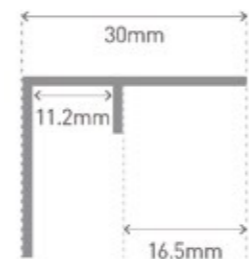

Perfect for straight walls our new 'invisible' internal corner profile has a hidden edge for a completely profile free finish.

PVC Profiles

Achieve a seamless finish between walls and floors with PVC seal strips. Use the options below to create elegant, curvilinear and easy to clean transitions.

NEW Floor to Wall Profile

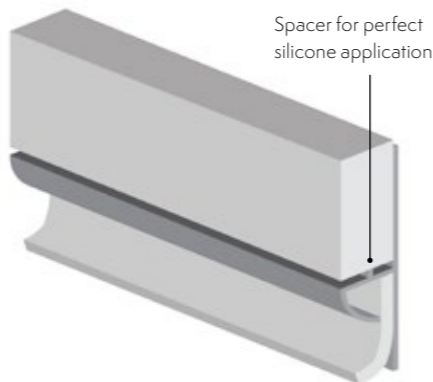

Type 103

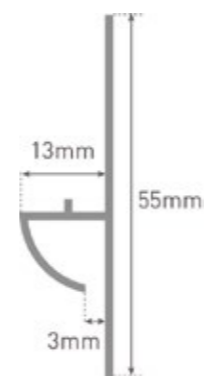

Our new PVC floor to wall profile gives a neat and accurate finish to vinyl floor and wall fittings. Easy to cut and fit, this trim allows the vinyl flooring to be changed without having to replace any of the panels. The ridge spacer provides the perfect gap for silicone sealant and the vinyl flooring can be fixed securely under the flap at the base of the trim.



Bath and Shower Seal MPSEAL

The innovative and stylish two-part shower tray and bath sealing system from Multipanel comprises a PVC strip and a high performance white silicone. The 'movement joint' expands and contracts to offer a reliable bottom seal. Supplied in 1.85m lengths, 2 in a pack.

Installing our panels with Multipanel adhesive

Multipanel has been designed with easy installation in mind. For the best result we recommend that panels are joined together using our unique Hydrolock® tongue and groove system. Panels using this system can be installed directly onto almost any surface, including uneven walls and over the top of old tiles. Multipanel High Grab Adhesive should be used for a safe and secure fit.

To join panels at a corner and to finish any exposed edges, the appropriate profile should be used. Panels must be completely silicone sealed at all edges using Multipanel sealant, whether they are being attached to profiles, shower enclosures or joined using the Hydrolock® system to ensure a 100% watertight result.

Our Multipanel Light Grey adhesive has been designed to replicate the exact grout colour that is used in our Tile Collection décors.

Multipanel High Grab Adhesive & Sealants



Light Grey
MPSILLG



White
MPADHS



Cream
MPSILCR



Dark Grey
MPSILDG

Perfect colour match for the Tile Collection grout line

Multipanel Silicone Sealants



White
MPSILWH



Clear
MPSILCL

Now with a 30 Year Warranty

- Declarations of all product performance are available at multipanel.co.uk
- Installation guidelines and full details on each product warranty can be e-mailed on request
- Multipanel High Grab Panel Adhesive/Sealant must be used and is available to order from your local distributor or showroom
- Multipanel 30 year warranty* covers the unlikely failure of the product, and will be invalid if any published installation and care guidelines are deemed not to have been followed



Installation tips

- Panels should be installed on the top of shower trays or baths using a Multipanel seal kit
- Match your profile colour to your shower enclosure and shower fittings
- Seal your installation using one of our colour matched sealants (see page 57)
- Carefully measure your area to select the right panel width, choose from 1200mm, 900mm and 598mm (remember, the Hydrolock® joint reduces the finished face by 20mm)
- Panel off cuts can be used behind sinks for a coordinated look. Just ensure you seal all exposed edges with profiles and silicone

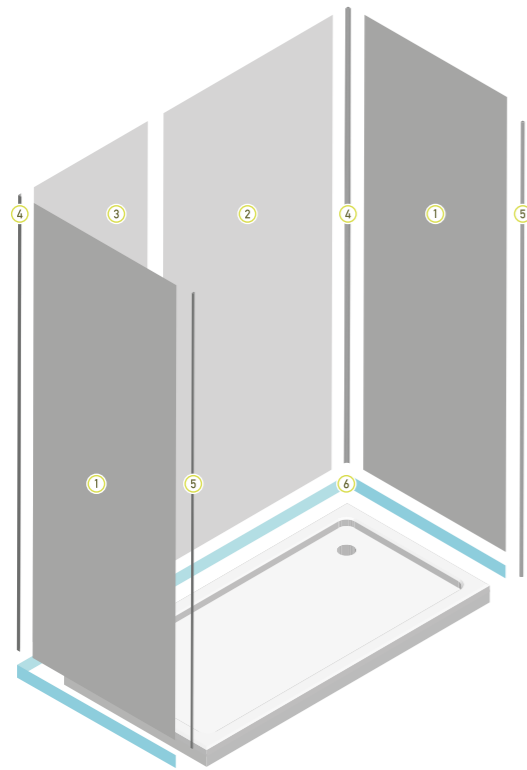

The illustration shows a typical installation of a 1800mm x 900mm shower enclosure

1. 2400 X 900mm Square edge panel x 2
2. 2400 X 1200mm Hydrolock® panel x 1
3. 2400 X 598mm Hydrolock® panel x 1
4. New Invisible Corner Profile x 2
5. End cap profile x 2
6. Seal kit x 2

Multipanel High Grab Adhesive x 3

Multipanel Clear Silicone Sealant x 2

Why choose Multipanel

Style and design are key to creating the bathroom of your dreams. But there are a whole host of other added benefits you get when using Multipanel instead of tiles:

	Multipanel	Traditional Tiles
Fully waterproof	✓	✓
No grout required	✓	✗
Resistant to mould	✓	✗
Quick and easy installation	✓	✗
30 year warranty	✓	✗
Made from sustainable materials	✓	?
Made in UK	✓	?

Learn with Multipanel

To help support installers, we created Multipanel University, a training programme designed to provide installation guidance and advice on how to install our panels.

Upon completion, you will receive a certificate of qualification and be entered into a prize draw to win a £100 Amazon gift voucher*.

*Terms & Conditions apply

